

OPERATES HERE

PUMP CURVE

FEET HEAD

DESIGN FLOW

GPM

Parallel and Series Pump Application



Bell & Gossett

a xylem brand

TABLE OF CONTENTS

Parallel Pumping Advantages	1
Paralleled Pump Curve Construction.....	2
System Curve Analysis – Parallel Pumping	2
Standby Operation	4
Parallel Pumping – Motor Selection	4
Pump Curve End Points	5
Multiple Parallel Pump Curves	5
Dissimilar Pumps Parallel Pump Curves.....	6
Open Parallel Pumping Systems	6
Parallel Pump Controllers.....	7
Parallel Pumping Example 1	8
Parallel Pumping Example 2	9
Pump in Series	9
Series Pumping Advantages.....	9
Series Pump Curve Construction	10
System Curve Analysis – Series Pumping	10
Series Pumping Example 1.....	11
Series Pumping Example 2.....	12
Combination Parallel & Series Pumping	12
Common Parallel-Series-Variable-Speed Pumping Application	13
Pump Application Software	15

NOTE:

Pump curves and other product data in this bulletin are for illustration only. See Bell & Gossett product literature for more detailed, up to date information. Other training publications as well as the Bell & Gossett design tools described in this booklet including the System Syzer®, analog and digital versions, and ESP Plus are all available from your local Bell & Gossett representative. Visit www.xylem.com/brands/bellgossett for more information or find your local Bell & Gossett representative at www.completewatersystems.com/resource-center/sales-distributor-contacts.

Introduction

There may be many reasons to use parallel or series pumps instead of a single, larger pump. These may include:

- Lower initial cost
- Lower installation cost
- Increased redundancy
- Easier maintenance,
- Lower operating cost, and
- Significant energy savings.

The designer must possess clear knowledge of system design fundamentals in order to achieve these benefits. The design examples in this book will show how to employ pumps in parallel or in series while avoiding the pitfalls that sometimes entrap a careless designer. The final example in this book combines parallel, series, and variable speed pumping for optimal energy savings.

Parallel Pumping Background

Pumps are described as operating in parallel when they receive liquid from the same suction manifold, and discharge into a common discharge manifold. For purposes of this book, we'll assume that the pumps are located close together, and the suction manifold is well designed so that differences in suction pressure are small enough to ignore. If there are significant differences in suction pressure, for example, in a primary-secondary zone or "distributed" pumping system, special design procedures must be used to insure satisfactory operation. These special procedures are discussed in detail in other Bell & Gossett Design Manuals.

Sometimes, a designer will specify that two pumps, either one capable of handling full design flow, be installed in parallel. If either pump fails, the other one can quickly be brought up to speed to handle full flow. This practice provides full redundancy. While this level of redundancy is sometimes essential, it's not often required in hydronic systems. For purposes of this book, the parallel pumps will be selected so that each one can provide something less than full design flow, resulting in lower initial cost compared to the full redundancy alternative. But this also means more than one pump will be required to meet full flow conditions. Typical load profiles for HVAC and plumbing pumping applications compiled for the Bell & Gossett ESP-Plus® pump selection and pumping analysis software (www.completewatersystems.com/tools/pump-selectors-3) show that these systems rarely operate at full design load. Systems designed with several smaller pumps in parallel can use manual or automatic pump "staging". Staging means varying the number of pumps in operation to meet changing load requirements. Done properly, staging can save energy and reduce operating costs, assuming that the pump staging is done wisely. Parallel pumping can provide a very high percentage (70% to 90% in most cases) of full flow at low cost compared to the full redundancy alternative. It's common in many HVAC systems to install three pumps in parallel, each sized to handle one-half the full flow. During most of the load profile, one, or sometimes two pumps would be in operation, with the third pump as a stand-by. In the unlikely event that two pumps failed at the same time, the remaining pump would be capable of handling 70% to 90% of the design load.

Pumping systems with a static head component, such as cooling tower/condenser water systems, domestic water pressure booster; or variable speed pumping systems that must maintain a constant differential pressure for proper operation are excellent candidates for parallel pumping application.

Bell & Gossett makes pumps to order, (BTO) as well as "stock" pumps that are popular, often requested. Stock pumps usually have much shorter procurement lead times compared to a BTO pump. Although centrifugal pumps are robust, they can fail. If they do fail, it's usually easy to restore them to full operation. Nevertheless, there may be situations requiring an expedited pump replacement, where a single stock pump for the necessary design point is unavailable. Designing the system with a combination of readily available stock pumps provides another level of redundancy.

Large pumping applications that require special order pumps, motors, and/or drives are excellent candidates for smaller parallel pumps. Smaller pumps may have a lower first cost and may also cost less to install, operate, and maintain.

Parallel Pump Details

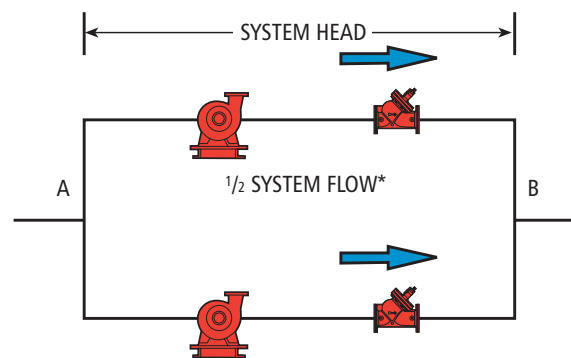

**Basic Parallel Pump Installation
Figure 1**

A simple example of two parallel pumps is shown in Figure 1. Important details like suction diffusers and isolation valves are not shown. In order to illustrate the concept of parallel pumping, we'll use two pumps, each sized for one-half of full system flow. Note that for two identical pumps in parallel, the total system flow divides at Point "A" in the suction manifold into two parallel paths through the pumps and check valves. At Point "B", the flows rejoin and go to the system. The increase in total head from "A" to "B" provided by the pumps will always equal the system head loss as measured from "B" to "A". The check valves at the pump discharge are essential to prevent backward flow through the idle pump when only a single pump is running. A Bell & Gossett Triple Duty® Valve could be used to provide the check valve as well as other important functions at the pump discharge. Note the asterisk in the pump flow legend. The actual flow rate in each branch will be greater than half of full flow, even though each pump will be selected for half flow. The actual flow increase above 50% cannot be determined until the full analysis is completed.

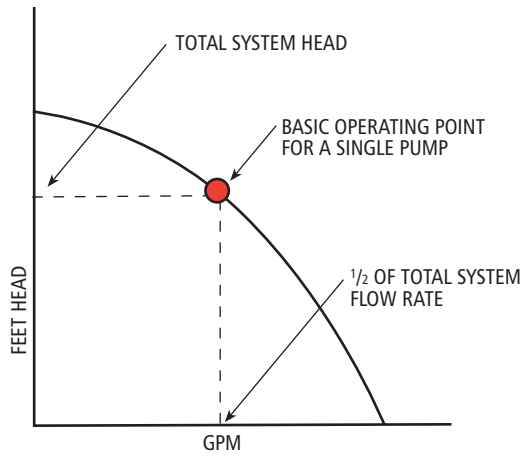

**Basic Paralleled Pump Operating Point
Figure 2**

Figure 1 shows that each pump in a two pump parallel system with identical pumps is pumping one-half of the total design flow rate. If the pumps are identical, and are pumping the same flow rate, it follows that each pump will produce the same pressure head. As shown in Figure 2, each pump is operating at the same point on its pump curve; one-half of the total flow rate at the total system head when both pumps are running.

Paralleled Pump Curve Construction

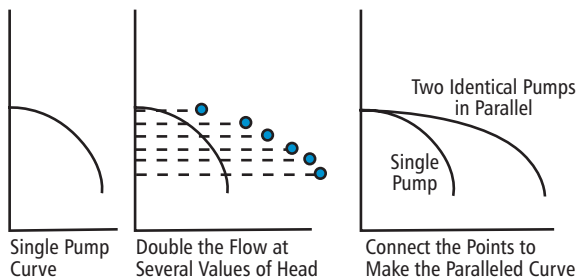

**Two Identical Pumps Paralleled
Pump Curve Construction
Figure 3**

If both pumps are operating, the system flow will be determined by the combined action of both pumps. In effect, the system reacts as if a single, larger "phantom" pump were installed between Points "A" and "B" in Figure 1. To construct the composite paralleled pump curve, select several values of head on the single pump curve, double the flow at that head, and plot the points. Connect the points to determine the combined effect of both pumps in parallel. This procedure is shown in Figure 3.

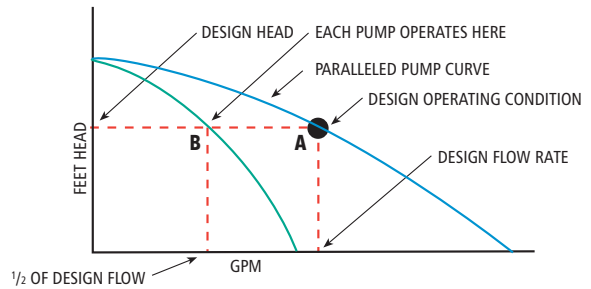

**Two Parallel Pump System Operation
Figure 4**

The point of system operation when both pumps operate is on this "paralleled pump curve", Point "A" in Figure 4. Each pump operates on its curve at Point "B"

System Curve Analysis - Parallel Pumping - Closed System

The next step in the analysis is to plot a system curve using the design operating condition as a basis. The system curve represents the flow-head loss relationship for a specific piping system. Later, it will also illustrate the changing patterns of pump operation which are accomplished by flow rate variation due to the action of control valves in the system. The system curve may be established using either the system curve equation or the Bell & Gossett System Syzer®.

System head loss can be calculated knowing the pipe size, pipe length, and design flow rate. Head loss in other components like fittings and terminal units must be considered too. For example, assume that a design flow of 200 GPM results in 30 ft. of head loss in a specific system. Similar calculations at other flow rates would establish other pressures drops, e.g. 11.8 ft. at 125 GPM and 4.2 ft. at 75 GPM. These points can be plotted on a head versus flow graph and connected to form a system curve.

It is not necessary, however, to make a series of calculations to establish a system curve. This is because friction loss varies in a mathematical ratio with the change in water flow rate. System dynamic head will change approximately as the square of the change in water flow:

$$\left[\frac{Q_2}{Q_1} \right]^2 = \frac{H_2}{H_1}$$

Where:

Q₁ is the design flow rate, GPM

Q₂ is a different flow rate

H₁ is the design head loss at design flow, in Ft Head Loss

H₂ is the new head loss corresponding to flow Q₂

Formula 1

System Curve Equation

For a system that has only friction loss, this relationship can generate a system curve, which shows how friction loss varies with changes in flow. Using 200 gpm and 30 feet of head loss as the design point, the following table shows the head loss for a variety of other flow values:

GPM	Head Loss (feet)
115	9.9
165	20.4
185	25.7
200	30
215	34.5
230	39.7

The circular, plastic "System Syzer" calculator has long been used in hydronic system design; for sizing pipe, selecting valves, and drawing system curves. Scale 5 of the calculator shown in Figure 5 is the GPM versus Head Loss scale used to develop the system curve.

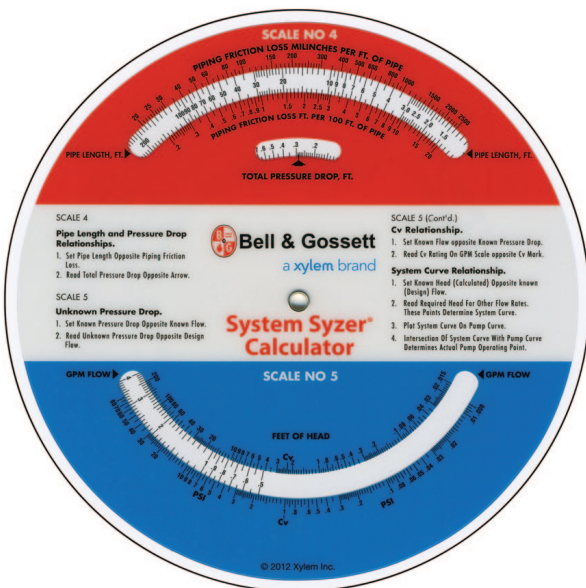

Analog Version of the Bell & Gossett System Syzer[®]
Figure 5

The Bell & Gossett System Syzer[®] program, a free download at www.completewatersystems.com/brand/bell-gossett/selection-sizing-tools/system-syzer, is an alternative to the analog calculator. It can be used to quickly estimate a system curve. The "Pressure Drop/System Curve/Cv" section of the program is in Figure 6. Simply enter design flow and head as "Known Flow" and "Known Head" values, in this case the design flow is 200 GPM and head 30 ft. Next enter the "Unknown Flow" and/or the "Unknown Head" value. The System Syzer[®] will estimate the respective unknown "Unknown Head" or "Unknown Flow." For example for 230 GPM entered for "Unknown Flow," 39.7 would be displayed for "Unknown Head." This operation can be repeated until enough system curve points are obtained to plot the system curve on the paralleled pump curve.

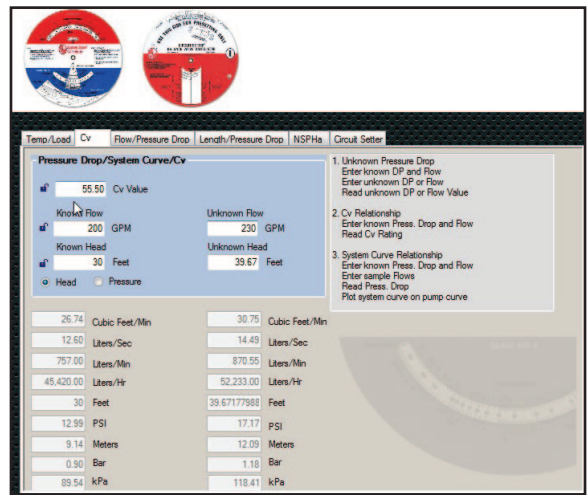

System Syzer[®] System Curve Calculation
Figure 6

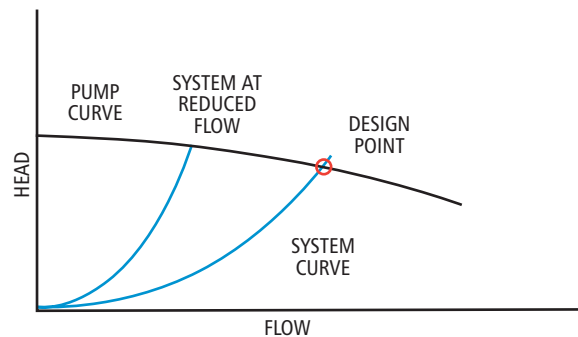

The System Curve
Figure 7

The operation of a pump in a piping circuit described by this system curve must be at the intersection of the pump curve and the system curve. The concept of conservation of energy requires that the energy applied to the water by the pump must match the energy lost by the water to friction as it flows through the piping circuit. Total flow through the piping circuit must match pump flow. The point of intersection of the pump curve and the system curve is the only point that can meet this basic engineering law. This assumes, of course, that the specified design point, 200 GPM at 30 ft. of head, accurately describes the system flow and pressure drop relationship. The "Design Point" shown in Figure 7 is achieved when the demand for flow is at the expected design rate. For example, in a system that uses valves to control flow, those valves would be open, allowing design flow. The valves are part of the system, so if they close to reduce flow, the system curve must change too. It now intersects the pump curve at reduced flow as shown.

Plotting a system curve is absolutely essential in applying pumps in parallel. Additional pump curve and system curve information can be found in other Bell & Gossett publications. These are available from your local Bell & Gossett Representative.

Standby Operation

One of the major benefits of parallel pumping is standby protection. The function of a standby pump is to take over or continue the pumping function if the first pump goes out of service. With parallel pumping, if one pump is out of service, the remaining pump can still provide a high degree of the design flow requirement. Remember that the point of operation will always be the intersection of the pump curve and the system curve.

Figure 8 shows two identical pumps operating in parallel. Note that the intersection of the parallel pump curve and the system curve, Point A, is the operating point when both pumps are running. Each pump is actually operating at Point B supplying one-half of the total flow at the required head.

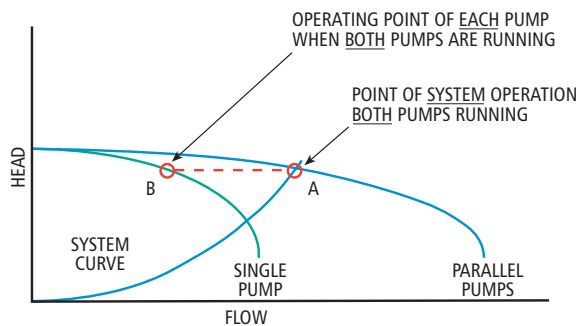

**Paralleled Pump System Operation
Figure 8**

If one pump fails, or is taken out of service, the composite paralleled pump curve disappears, and the point of operation shifts to the intersection of the single pump curve with the already established system curve. This is shown as Point C in Figure 9. It's important to note that the flow rate from the single pump will increase above the amount that the single pump was delivering when both pumps were running. The head produced by the pump will decrease. The flow rate will now be established by Point C in Figure 9.

The system curve analysis determines the flow rate that will be provided by the single pump, and therefore the stand-by capacity. The single pump in a two equally sized parallel pump application will always provide more than half of the design flow. How much more than one-half is determined by the pump and system curve analysis. The size of the piping in the pump branch is also determined by the system curve analysis. Even though the pump is sized for half of the design flow, the piping attached to the pump must be able to handle the increased flow that will occur during single pump operation. Other components are also affected by this analysis: Triple Duty Valve, suction diffuser, if applicable, strainers, fittings- all must be selected for the greater flow rate.

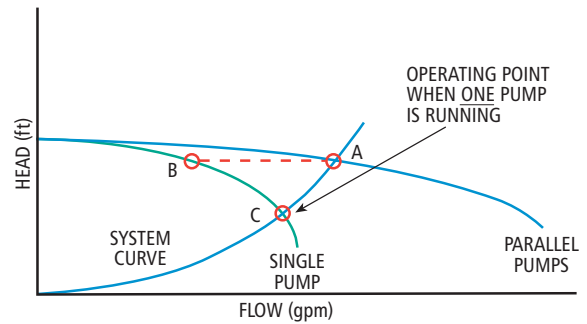

**Single Pump Operation - Paralleled Installation
Figure 9**

As flow through the single pump increases, the Brake Horsepower (BHP) also increases in most cases. The motor horsepower requirement is usually greater for the single pump running alone than when it operates in parallel. The rare exception would be a pump whose discharge head decreases enough and/or the efficiency increases enough at the single pump point of operation to cancel out the effect of the increased flow. The required BHP, flow in GPM, head in feet and pump efficiency in centrifugal pumps can be estimated by means of the BHP formula below:

$$\text{BHP} = \frac{\text{gpm} \times \text{feet head} \times \text{SG}}{3960 \times \eta \text{ pump}}$$

Where:

"SG" is the specific gravity of the liquid, and η is the pump efficiency. Neither of these quantities have units. The constant 3960 yields the BHP in units of horsepower.

Formula 2

For more details on this or other pumping formulas see other Bell & Gossett publications, available from your local Bell & Gossett Representative (www.completewatersystems.com/resource-center/sales-distributor-contacts).

Parallel Pumping - Motor Selection

The motor for a pump in a parallel pumping application must be large enough for the horsepower required when it is the only pump running. If this is not done the motor may shut down on overload or fail when the system goes to single pump operation. For this reason it is important to analyze the "worst case" horsepower requirement, and provide a motor that's large enough to meet that requirement. In simple applications, the worst case point is shown as Point C in Figure 9. In Figure 10, the three parallel dotted lines represent lines of constant horsepower. When both pumps are running, each pump operates at Point "B", the system at Point "A". Each pump is using a little less than 40 hp. A designer may have selected a 40 hp motor with a service factor of 1.15, a typical general duty motor that could provide as much as 46 hp operating at the limit of its service factor. ($40 \times 1.15 = 46$ hp)

During single pump operation, with no change to the system, the single pump will run out to Point "C", where it will require slightly more than 50 hp, causing the 40 hp motor to exceed its service factor and overload.

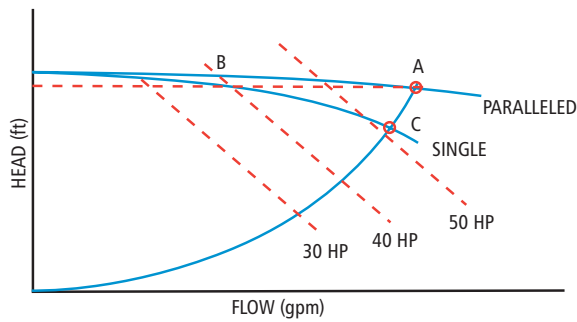

BHP Increase During Single Pump Operation
Figure 10

Pump Curve End Points

Curves describing the operation of larger pumps will have end points as shown in Figure 11. A pump must not be allowed to operate beyond that point; the pump curve must not be extrapolated to higher flow rates. Operation beyond the published end point can result in pump cavitation with unstable operation, poor efficiency, and eventual failure. It is very important to analyze the entire system operation to assure pumps are not operated beyond their pump curve "end point."

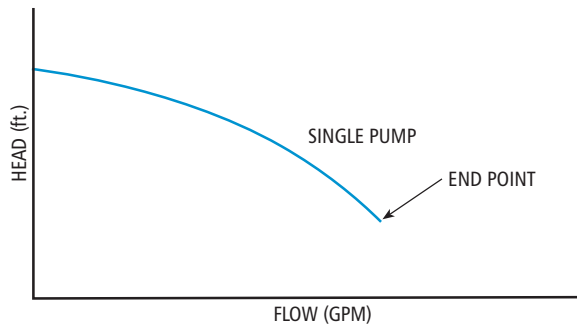

Pump Curve End Point
Figure 11

Figure 12 illustrates that no point of intersection between the published single pump curve and the system curve exists. If single pump operation were attempted with no change to the system curve, the single pump would be operating beyond the area of operation the pump manufacturer has specified for that pump. The solution to this problem is to select a different pump, one that puts the design operation point up higher to the left on the pump curve or to specify a pump controller with algorithms that take into account pump curve end point protection. Parallel pump controllers will be discussed later.

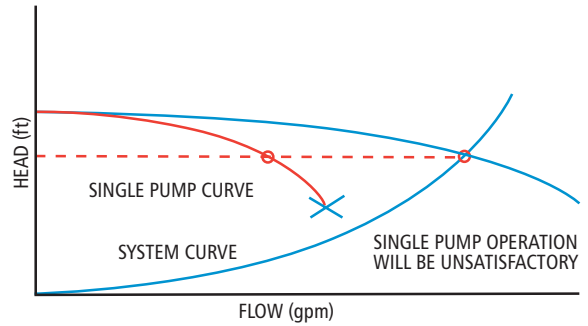

Unsatisfactory Single Pump Operation
Figure 12

Larger Pump Systems

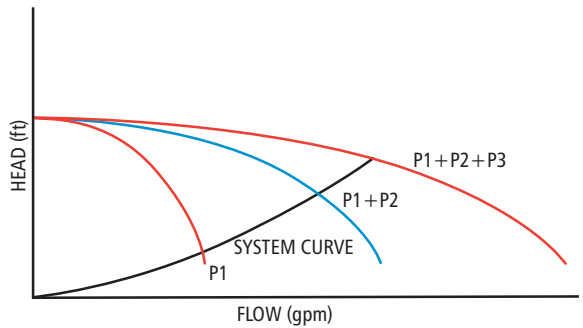

Three Pump Paralleled Pump Curve Construction
Figure 13

Figure 13 shows the effect of three identical pumps operating in parallel. Each of the three pumps was selected for one-third of the design flow at full design head. That is also the point of operation for each pump when all three are running and the system is at design conditions. The point labeled P1+P2+P3 is the point of system design operation, where the resulting parallel pump curve for all three pumps running intersects the system curve. P1+P2 is the point of operation with only two pumps running with the system unchanged. P1 indicates the point of operation with only one pump running with no changes in the system control valves. In theory there is no limit to the number of pumps that can be operated in parallel as long as the designer protects against motor overload and operation beyond the pump curve end point. As the number of pumps in parallel increases, the potential for a single pump running by itself to operate past its pump curve end point increases. On the other hand, the marginal effect of each additional pump in parallel becomes smaller.

Dis-similar Pumps in Parallel

Many parallel pump applications use identical pumps. Some applications can benefit by using dissimilar sized pumps, although some additional cautions must be observed. Figure 14 shows a larger and smaller pump installed in parallel. As in the earlier example, each one is equipped with a check valve or Triple Duty® Valve at its discharge to prevent backward flow through the idle pump.

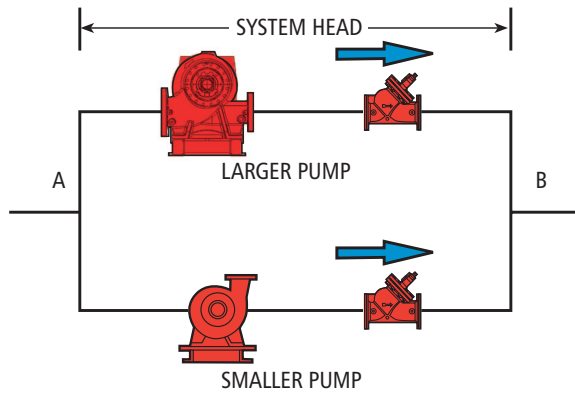

Dis-similar Pumps in Parallel
Figure 14

Dissimilar Pumps Paralleled Pump Curve

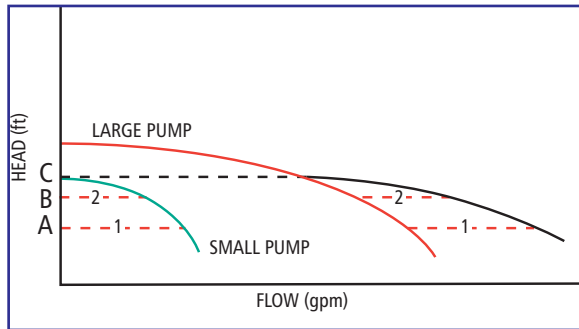

Small Lower Head Pump; "Piggybacks" its Flow-Head Curve onto Larger Pump
Figure 15

When dissimilar pumps operate in parallel the composite curve is established as before by selecting several values of head, identifying the flow provided by each pump at that head, and adding them. This is shown in Figure 15. At "A" feet of head, the small pump provides Flow "1", which is added to the greater flow provided by the larger pump. At "B" feet, the smaller pump adds Flow "2" to that of the larger pump. Point "C" is the shut-off head for the smaller pump, so at that value of head, the smaller pump can't add anything to the flow of the larger pump. This produces a discontinuity, or "hump" in the composite curve. As long as the system curve intersects the composite curve below "C" feet of head, both pumps contribute to the flow. If the system curve intersects the composite curve above "C" feet of head, the larger pump will provide more head than the smaller pump's shut-off head, closing the smaller pump's check valve. Prolonged operation against a closed discharge valve (dead heading) can result in severe damage to a centrifugal pump.

Designers must consider how and when pumps will be staged in parallel pump applications. As flow rate increases or decreases, the number of pumps in operation must be adjusted. This can be done manually, but it is far more likely that a "pump controller" will do it automatically. With dissimilar pumps in parallel proper control of switch-over points is critical. Unless the pumping system is carefully designed and controlled, the smaller head pump may be closed by a higher head pump.

Dissimilar pumps are often found in domestic water pressure booster applications. The smaller or "jockey" pump is used to save energy during periods of low water usage. Automated controls plus back-up mechanical means of controlling and relieving the thermal energy rise produced by pump dead heading should be incorporated into pressure booster design. Detailed pressure booster design information can be found in other Bell & Gossett publications, available from your local Bell & Gossett Representative (www.completewatersystems.com/resource-center/sales-distributor-contacts).

Open Parallel Pumping Systems

In open systems, the liquid is exposed to a compressible gas, usually the atmosphere, at more than one point. Special definitions apply to open systems. These definitions do not apply to closed systems. In plotting the system curve for an open system the static head of the system must be taken into account in addition to the friction loss. The three possible static head conditions are illustrated in Figure 16. All three conditions are covered in detail in other Bell & Gossett Bulletins available from your local Bell & Gossett Rep. (www.completewatersystems.com/resource-center/sales-distributor-contacts).

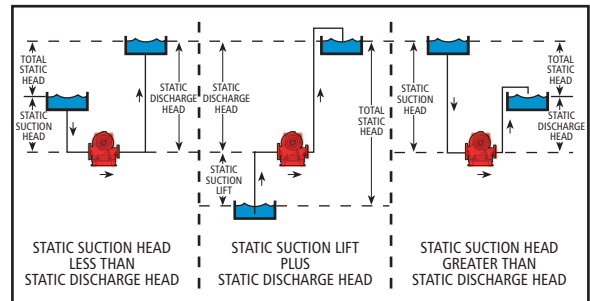

Open System Definitions
Figure 16

The "Total Static Head" in each of these systems represents the net liquid level elevation difference between the source of the liquid and the liquid delivery point. It represents an additional amount of work required from the pump in lifting each pound of water against gravity through the total static head. System curves for open systems must reflect this additional requirement.

Cooling towers are often open systems. They reject heat from the chiller condenser to the atmosphere. Parallel condenser pumps are used in large chilled water systems for the same reasons already discussed; redundancy, operating cost savings, and so on. Parallel pump curve construction for an open system is similar to the procedure used for closed systems. Pumps in parallel will operate where the composite parallel pump curve intersects the system curve.

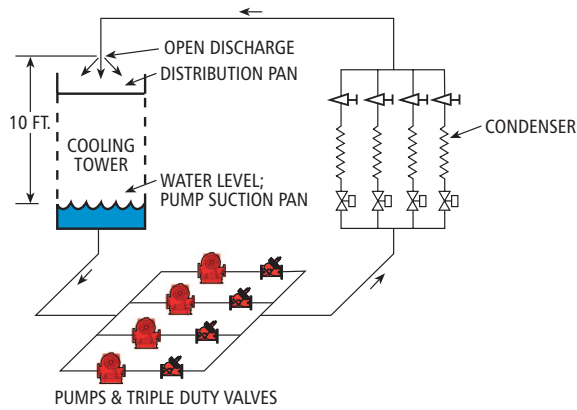

Typical Large Condenser Water System
Figure 17

In Figure 17 the pumps draw cool water from the tower sump then discharge it through the condensers as warmer water at the top of the tower. The top is 10 ft. higher than the sump level. Total friction loss, including suction and discharge piping, condenser, valves is 50 ft. at the design flow rate of 6000 GPM. The pumps must be selected for the total head: 10 ft. of static head due to elevation differences plus 50 ft. due to friction. For this application the designer would select a single large pump or a set of smaller pumps in parallel to deliver 6000 GPM at 60 ft. of head.

To build the system curve, estimate total head for each of the desired flow rates. Head due to friction will change with flow as described by Formula 1 or the System Syzer® program. Static head remains constant, independent of flow. Note, in the table below, that at zero flow the static head is 10 Ft.

Flow GPM	Friction Loss Feet	Static Head Feet	Total Feet
6600	60.5	10	70.5
6000	50.0	10	60
4200	24.5	10	34.5
3000	12.5	10	22.5
1800	4.5	10	14.5
0	0	10	10

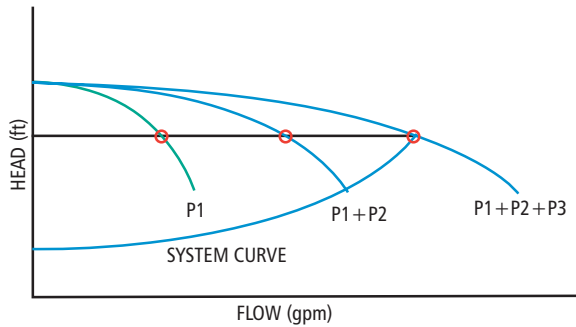

Three Parallel Pumps; Open System
Figure 18

Four pumps in parallel, each selected for one-third of the design flow will be considered, with the fourth pump used only for back-up. Thus, any three pumps can provide full design flow, fewer pumps for reduced flow at part load. Figure 18 shows pump curves for one, two and three pump operation. Construction of the parallel pump curve is the same as before. The system curve originates at 10 feet at zero gpm and proceeds according to the values from the table. The System Syzer® cannot account for system static head. The designer must remember to account for the total head.

Staging the pumps to match the load requirements would produce significant energy savings. Energy savings could be further enhanced by also operating the pumps at variable speed. For more details on variable speed operation and staging of parallel pumps or for more details on cooling tower pumping problems see other Bell & Gossett technical bulletins available from your local Bell & Gossett Representative (www.completewatersystems.com/resource-center/sales-distributor-contacts).

Parallel Pump Controllers

Many systems are designed for "variable volume". That means the flow is not constant, but changes in accordance with the needs of the people who use the system. Some common examples include a plumbing system providing potable water throughout a building. As someone opens or closes a faucet, the system flow varies. (Another example is a heating or cooling system where the desired room temperature is maintained by a thermostat which automatically regulates flow to the coils in order to balance heat transfer at the coil to the current conditions in the room.) Since the faucets and two-way control valves are part of the system, they will change the system curve as they open or close. This change in the system curve provides a means for determining how many pumps should be in operation. The discussion surrounding Figure 12 illustrated that a single pump may run off the end of its curve if one of two parallel pumps fails when the system is at full design flow. But what if the system is at reduced flow? Figure 19 shows this situation.

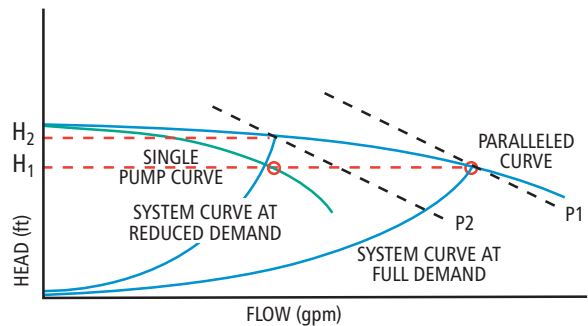

System at Part Load
Figure 19

When the valves close and the system curve warps to the left, one of the pumps can be turned off, reducing wear on the pump and energy use. It would be inconvenient to turn off the pump manually, so a pump controller can be installed in the system to do it automatically.



**Domestic Water System Pressure Booster Package
Figure 20**

Figure 20 is a pump package used to provide domestic water to a plumbing system. Two small pumps boost the pressure supplied by the city water system so that all the plumbing fixtures in the building will always have adequate pressure in spite of flow demand or static height. Assume that they have been sized so that each one can provide one-half the flow at full head, although some designers use different proportions to "split" the design flow.

In Figure 19, full flow requires both pumps, each operating at h_1 , each using a little less than P2 horsepower. As the system valves close, flow is cut to one-half, the system curves warps left, head rises to h_2 , each pump retreats to the left on its curve, using less horsepower, and therefore drawing less current through its motor leads. That reduction in motor current has long been used as an automatic signal to de-stage a pump. Motor current is not linearly related to horsepower, especially at low load, so a better way to de-stage the pump is to actually compute the horsepower being used. Bell & Gossett controllers often use that method. Other ways to provide automatic control would require external sensors in the system; flow meters, or pressure sensors could achieve the same effect. As valve open and system demand increases, the system would react by staging the pump on. Pump controllers can easily be programmed to avoid the end-of-curve problems described earlier. With a single pump in operation, increasing demand will warp the system curve to the right, approaching the curve end-point. The controller automatically senses the situation, stages on the next pump, the original pump would then retreat back toward the middle of its curve.

Parallel Pumping Example 1

The first step in any pumping situation is to establish a design pumping requirement. Assume a design pumping requirement of 120 GPM at 35 ft. head. The pump capacity curves in Figure 21 show that this requirement cannot be met using a single small pump.

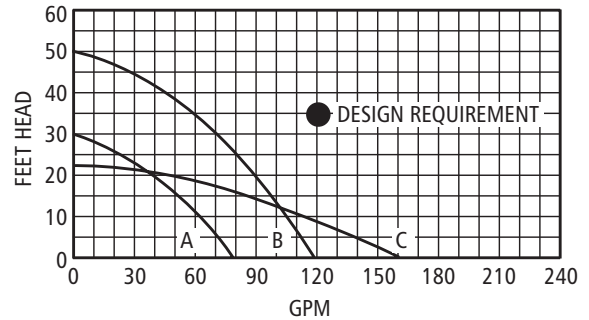

**Typical Small Pump Curves
Figure 21**

Two small pumps in parallel rather than a single large pump will be used. In order to determine which of the small pumps is best suited, divide the design flow requirement in half, as each pump will provide one-half of the total flow at the full design head.

Each pump must then deliver 60 GPM at 35 ft. head. The design requirement can then be achieved using two "B" pumps mounted in parallel.

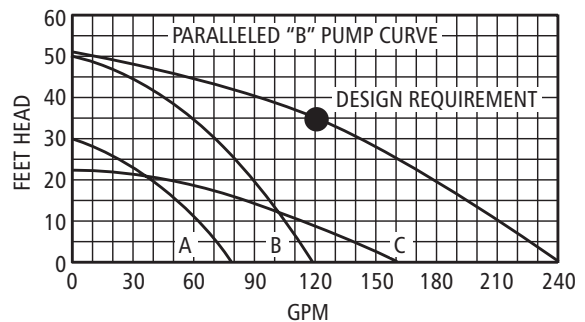

**Paralleled "B" Pump Curve
Figure 22**

Second, plot the composite pump curve as shown in Figure 22. The design requirement, 120 GPM at 35 ft. head, is one point on the paralleled pump curve.

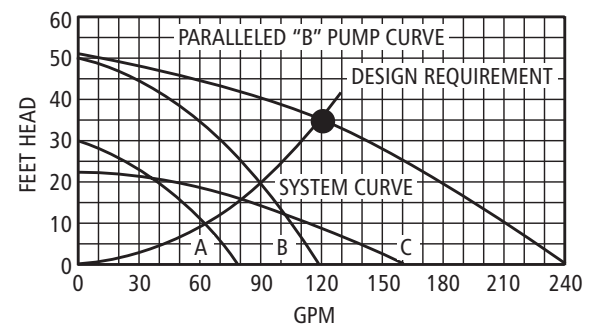

**System Curve
Figure 23**

Third, plot the system curve using the Bell & Gossett System Syzer® program. The design requirement (120 GPM at 35 ft. head) is one point on the system curve.

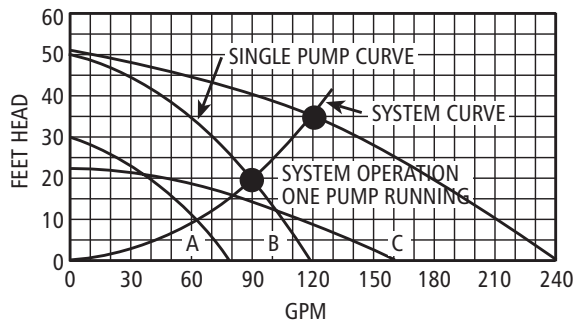

Single Pump Operation
Figure 24

Fourth, determine the flow rate that one pump will deliver when it is running alone. This is determined by the intersection of the single pump curve with the system curve. For the example problem, one "B" pump running alone will deliver 90 GPM at 20 ft. as shown in Figure 24.

This 90 GPM represents 75% of the total flow requirement. For this application, 75% of full capacity is provided at little or no increase in cost compared to the larger, single pump alternative. If this were a heating application, one pump would produce enough flow to provide sufficient heating in all but the most severe weather.

Fifth, check to insure that the motor is large enough to allow single pump operation as previously discussed. Small pumps like these are often provided with "non-overloading" motors, which means that the motor is large enough to operate anywhere on the impeller curve.

Parallel Pumping Example 2

Assume a pumping requirement of 1200 GPM at 60 ft. head. Using two pumps in parallel will provide favorable operating characteristics and economical standby protection. To determine what each pump must deliver, divide the total pumping requirement by the number of pumps which will be used.

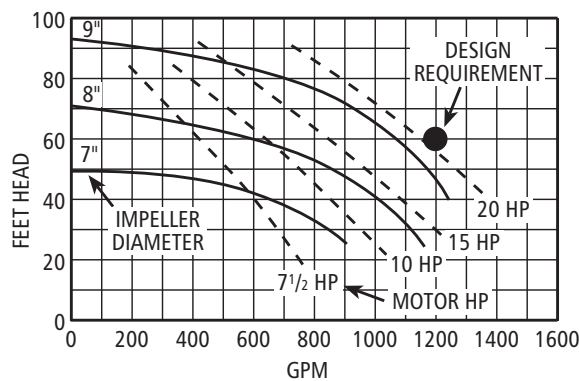

Typical Larger Pump Curves
Figure 25

In a two pump system, each pump must deliver 600 GPM at 60 ft. head. Figure 25 indicates that the pumping requirement is best met by two pumps with an 8" diameter impellers.

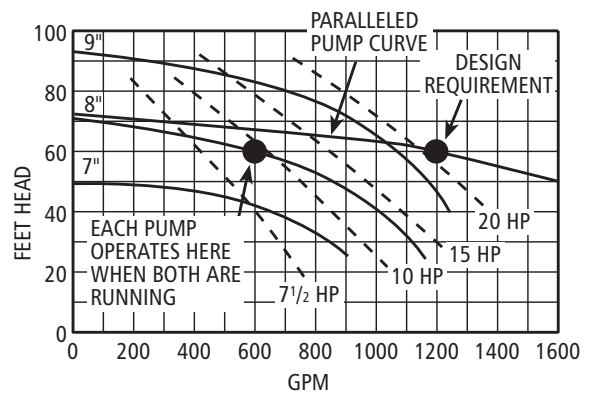

Paralleled Pump Curve
Figure 26

Plot the paralleled pump curve for two pumps using the 8" impeller diameter curve as a base as illustrated in Figure 26. During single pump operation, the point of system operation will be the intersection of the single pump curve and the system curve. One pump operating alone will deliver approximately 990 GPM at 41 ft. head. The 990 GPM represents slightly over 82% of the design flow requirement. Figure 27 shows that a 15 horsepower motor will be adequate under all conditions of system operation.

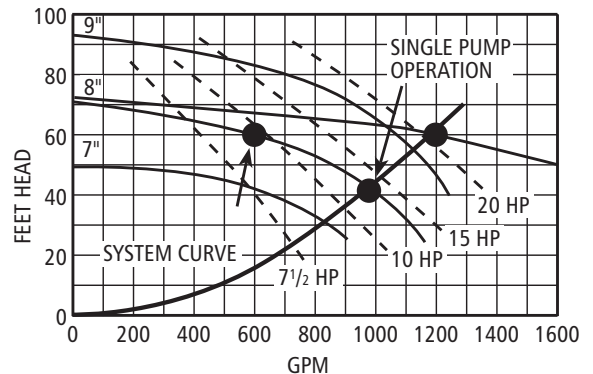

Single Pump Operation
Figure 27

Pumps in Series

Series Pumping Advantages

Series pumping offers many of the same advantages attributable to parallel pumping. Series pumping can reduce costs by using a combination of smaller pumps rather than a single larger pump to accomplish a certain pumping task. This may reduce installation costs as well as operating costs. Series pumping using two or more smaller pumps to handle the total pumping requirement will also provide a high degree of standby capacity. The standby percentage will generally be a high percentage of total system requirements. Large pumps may have very high NPSH Requirements. In order to avoid cavitation, a smaller pump could be used in series, discharging into the suction nozzle of the larger one. This has the effect of increasing the NPSH Available at the larger pump suction.

A common method of piping pumps for series operation is shown in Figure 28. The valves allow either one or both pumps to be in operation.

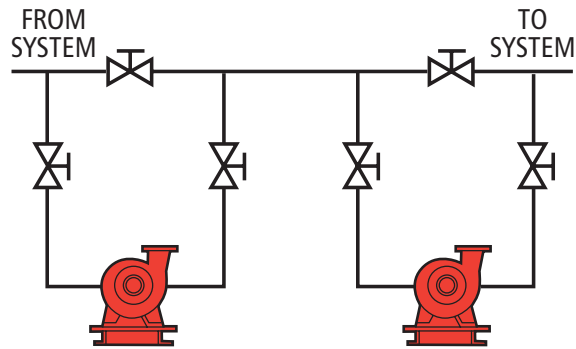

**Practical Series Pump Installation
Figure 28**

This type of piping arrangement allows either of the pumps to be valved off for routine maintenance without interrupting service to the system. Again note that for normal series operation, the total flow will pass through each pump.

Many series pump installations are made with identical pumps, although it is sometimes advantageous to use dis-similar pumps. In either case, each pump must be able to handle full flow, the pump heads add. From Figure 28 it can be seen that each pump will pump the entire system flow. A centrifugal pump will produce a pressure differential commonly known as pump head, usually stated in feet of head. Since series pumps are generally identical and they pump the same flow rate, it must follow that each pump will develop the same head. In other words, each pump supplies the full (design) flow rate at one-half of the required (design) head. This is shown in Figure 29.

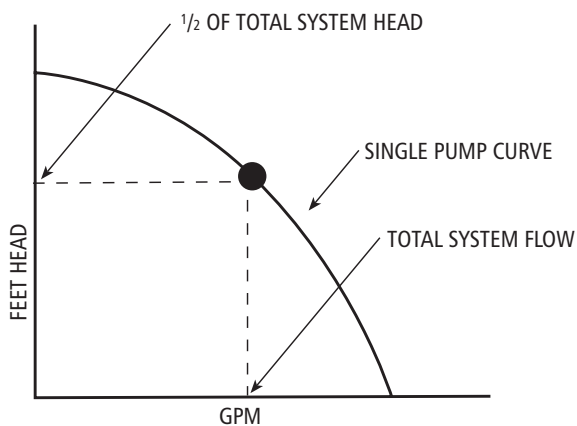

**Basic Series Pump Operation
Figure 29**

As in parallel pumping, it is necessary to establish a "seriesed pump curve", the composite curve which represents the combined effect of all pumps in operation. Construct this composite curve by doubling the head developed by a single pump at every flow rate as illustrated in Figure 30.

Series Pumping Curve Construction

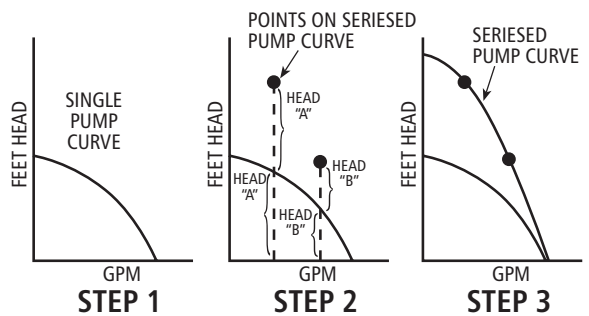

**Seriesed Pump Curve Construction
Figure 30**

It can be seen that putting pumps in series tends to steepen the overall pump curve. Pumping conditions requiring very high head may be met by placing pumps in series.

System Curve Analysis - Series Pumping

In order to accurately determine the available "standby percentage" or the flow a single pump could deliver in a given installation, it is necessary to plot a system curve. The system curve can be established as described above. Remember that the design head and flow requirement will be one point on the composite pump curve. Remember also that the design head and flow requirement will also be one point on the system curve. A typical system curve plot for a series pumping installation is shown in Figure 31.

Note that although the design operating condition, Point 1 - Figure 31, is on the composite pump curve, the point of operation of each pump is on the single pump curve, Point 2 - Figure 31. Each pump supplies one-half of the total head at the total flow rate when pumping in series.

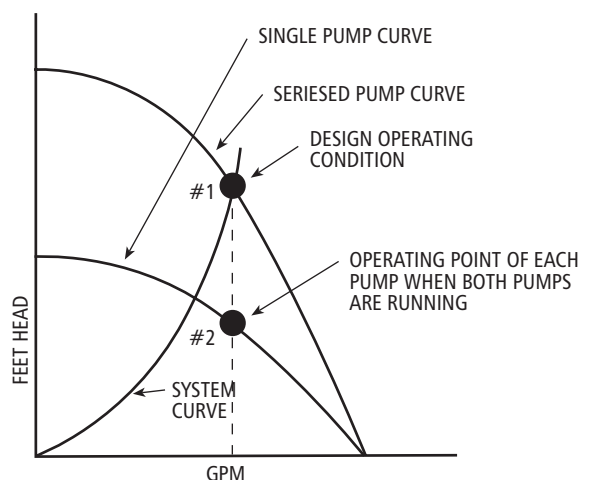

**Seriesed Pump - System Operation
Figure 31**

When only a single pump is running, the point of operation will shift to the intersection of the single pump curve with the system curve. This is shown as Point 3 in Figure 32. Keep in mind the basic rule that the point of operation must always be the intersection of the pump curve and the system curve.

Figure 32 shows that when the system goes to single pump operation, the flow delivered by the single pump will decrease. This means that the horsepower requirement will also diminish. Series pump applications require that the pump be supplied with a motor which is large enough for the pumping condition that will exist when both pumps are running; Point 2 - Figure 32. This is important to remember as it is the exact mirror image of the parallel pump situation.

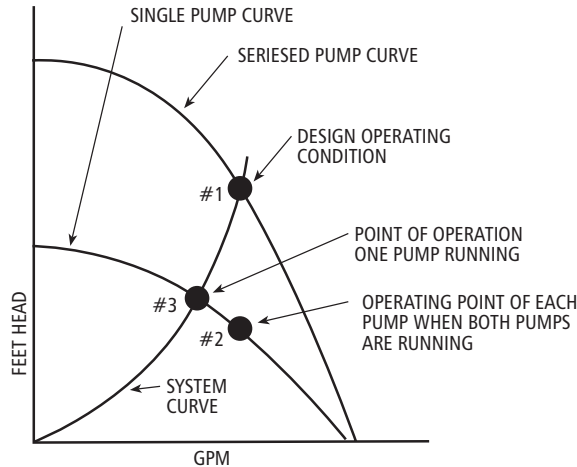

Single Pump Operation - Seriesed Installation
Figure 32

Series Pumping Example 1

First, determine the design pumping requirement. For this example, assume it is 75 GPM at 40 ft. Figure 33 shows that no single small pump is capable of producing this requirement.

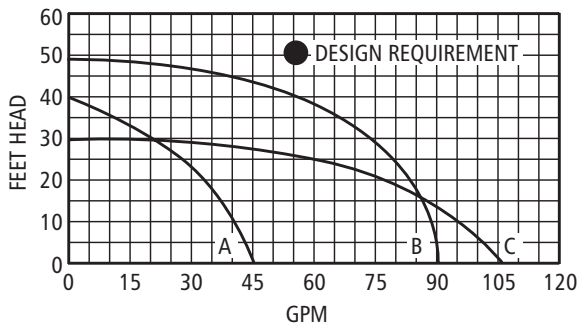

Design Requirement
Figure 33

Two smaller pumps in series or a single larger pump would meet the requirement. When two equally sized pumps are placed in series, each pump will deliver the total flow rate at one-half of the total head.

Each pump used in this example would then be required to deliver the entire flow rate, 75 GPM, at 20 feet of head. A "C" pump will deliver the required 75 GPM at 20 ft.

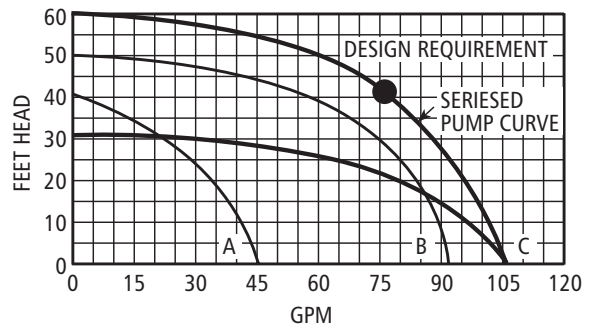

Seriesed Pump Curve
Figure 34

Next, plot the composite pump curve shown in Figure 34. Note that the design requirement, 75 GPM at 40 ft., is one point on the seriesed pump curve. In order to determine what percentage of standby capacity is available for this example, it is necessary to plot a system curve. Use the total design requirement, 75 GPM at 40 ft. as one point on the system curve and the Bell & Gossett System Syzer® to plot the system curve as shown in Figure 35.

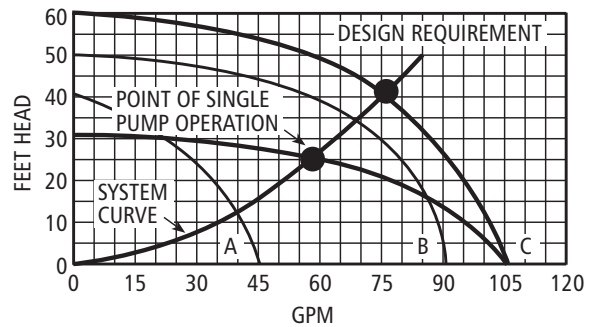

Single Pump Operation
Figure 35

From Figure 35 it can be seen that a single pump running alone will deliver approximately 58 GPM at 24 ft. head. This amounts to a bit over 77% of full capacity. It is important to note that this 77% of full standby capacity has been obtained with no increase in equipment cost from that of delivering the full design flow.

When employing series pumping, maximum motor horsepower requirement will usually occur when both pumps are running as the individual pump flow is greater. The interaction of required BHP, flow in GPM, head in feet and pump efficiency in centrifugal pumps can be estimated by means of the BHP formula as discussed earlier:

An analysis similar to that explained in the previous parallel pumping discussion should be undertaken. This is the basic analysis that should always accompany a series pumping application. The only way to get the actual picture of system operation is to complete this analysis. The few minutes of time required is well spent and easily prevents system pumping problems.

There is no theoretical limit to the number of pumps which can be placed in series. Three or more pumps placed in series can give a greater percentage of available standby protection. As the discharge pressure developed is additive for pumps operated in series, special attention must be given to the system and individual pump working pressure limitations.

Series Pumping Example 2

Assume a total pumping requirement of 1600 GPM at 140 ft. head. Use two pumps in series to meet this requirement. Each pump will then be required to pump the entire flow rate at one-half of the required head. Each pump must then deliver 1600 GPM at 70 ft. head. From Figure 36 shows that each pump would need an 11" diameter impeller.

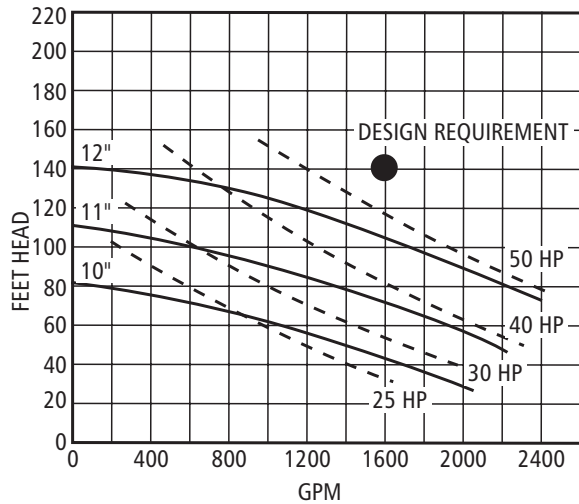

**Design Requirement
Figure 36**

Next, plot the composite pump curve and the system curve as shown in Figure 37. When a single pump is running alone, it will deliver approximately 1210 GPM at 82 ft. This is the intersection of the single pump curve and the system curve. It's approximately 75% of total design flow. A 40 horsepower motor will be adequate for both single pump operation and series pump operation.

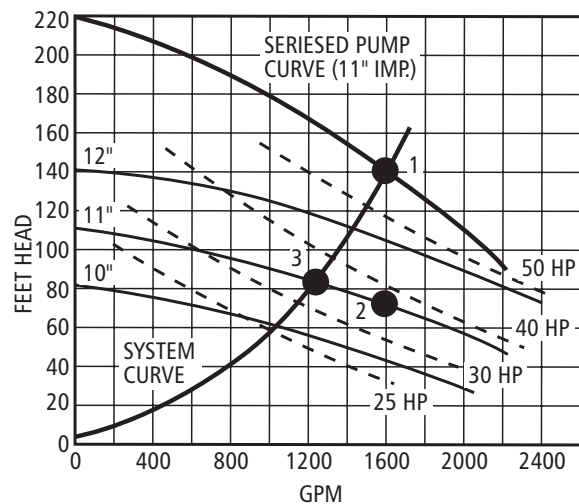

**Seriesed Pump Operation
Figure 37**

1. The point of system operation with both pumps running.
2. The point of operation for each pump when both pumps are running.
3. The point of system operation with one pump running

Combination Parallel & Series Pump Application In larger installations:

- It may be necessary to provide for future expansion
- Combination heating and cooling systems require a high flow rate for cooling, and a relatively low flow rate for heating
- Systems which use two-way control valves can be stabilized by varying the pump operating point.

A wide range of possible operating points can be obtained by using pumps in both series and parallel. Figure 38 shows an installation of pumps in both parallel and series.

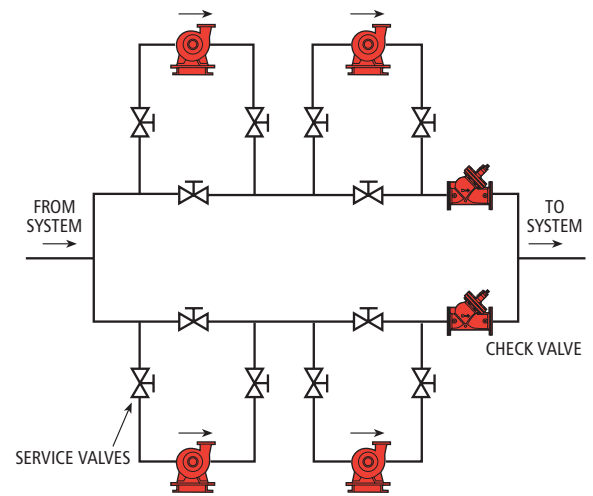

**Basic Paralleled & Seriesed Pump Installation
Figure 38**

The illustration shows two parallel banks with two pumps in series per bank. Use the same procedures described earlier to plot the possible operational pump curves that can be obtained with this installation.

Establish the seriesed pump curve using the single pump curve as a basis. Then plot a paralleled pump curve using the seriesed curve as a basis. Maximum individual horsepower requirement may be quickly established as it will occur when two pumps are running in series.

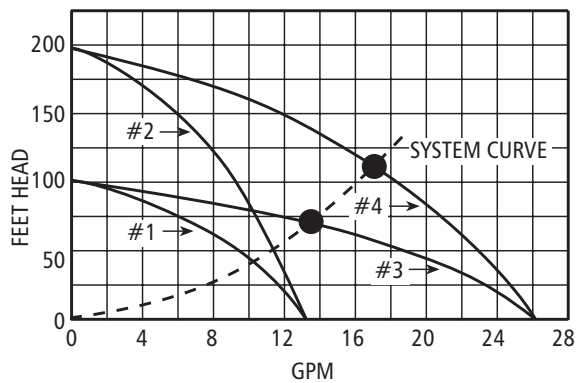

Combination Parallel & Series Pump Curves
Figure 39

Possible Operating Points

- #1 - Single Pump
- #2 - Two Pumps in Series
- #3 - Two Pumps in Parallel
- #4 - Two Parallel Groups of Two Pumps in Series

Figure 39 shows that four distinct pump operating points are available from this pump arrangement. These flow rates may be obtained by running a single pump, two pumps in series, two pumps in parallel, or all four pumps. Note that any three pump combination will dead-head a pump.

With properly instructed operating personnel, correct control and this type of pump arrangement, substantial operating cost savings can be realized as compared to a single large pump. As long as adequate minimum water velocities are maintained, only those pumps necessary to satisfy the system demand need be run. For this system, operation at design conditions might require 50 hp. Since the system will operate at much less than maximum load for the vast majority of the time, approximately 15 hp would satisfy most requirements.

In addition, the standby characteristics of a multiple pump installation are extremely favorable. By judicious use of the valves, the standby capability may be used to supply the system in spite of pump failure.

There is no limit to the number of pumps which may be placed in combinations of parallel and series. We recommend parallel and series pumping as one way of increasing pumping system flexibility although variable speed pumping can provide even more flexibility, and greater potential for energy savings. Used together, these design ideas can provide much better performance at lower initial cost and lower operating cost.

Designers must always apply these concepts with skill and good judgment to obtain the maximum benefits for their clients.

Common Parallel-Series-Variable-Speed Pumping Application

Domestic water pressure booster systems in modern tall buildings, often benefit from combination series-parallel-variable-speed pumping. A pressure booster pumping system must address large variations in flow and incoming municipal water pressure while delivering steady flow and pressure to the building plumbing fixtures

Both commercial and residential buildings have large variations in domestic water demand throughout the day. Pumps in parallel can be staged to meet varying flow loads. In tall buildings there is a large component of static pressure to be addressed. For example, a 20 story building with an average 12 ft. of elevation per level would have $(20 \times 12 = 240)$ 240 ft. of static head. The static head component is constant at all flows. Water pressure supplied from municipal water supplies to buildings in many areas can vary with the time of day and time of year.

Varying the speed of a single large pump is not practical for large flow and large static head applications. A reduction in pump speed reduces pump flow in proportion to the speed reduction, but it also reduces the pump discharge head by approximately the square of the speed reduction. This is shown in Figure 40.

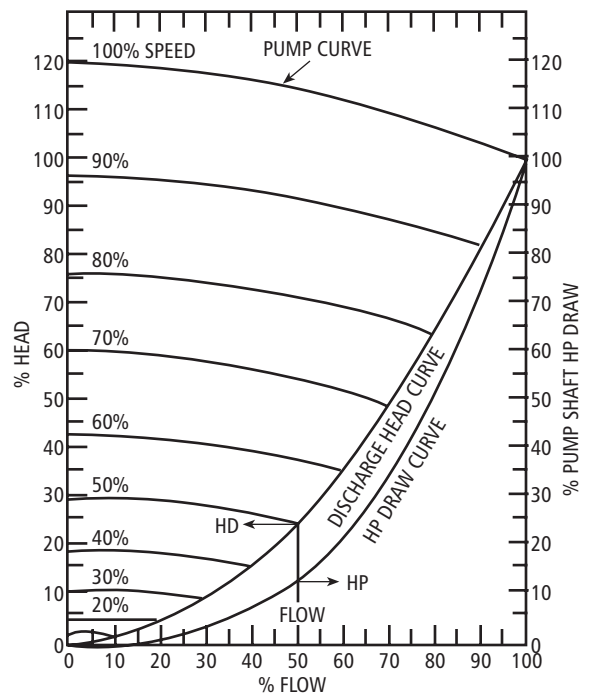

Theoretical Relationship Among Speed, Flow, and Head
Figure 40

Figure 40 illustrates the steep drop in pump discharge pressure as a function of pump speed reduction. At 50% speed flow is reduced to about 50%, while pump discharge head drops to about 25%, the square of the speed reduction:

With constant static head at all flows, a single large pump operating at variable speed would have little potential for energy savings. The range of speed variation is limited to the

reduction in piping friction loss at lower flows or variations in city supply pressure. Multiple pumps in parallel, staged to meet the load requirements, offer better savings potential when dealing with large static head loads that include large variations in flow. Pressure boosters have to be designed for the lowest expected water pressure entering the building. Anytime the pump suction pressure is higher than design the potential for further energy savings through pump speed reduction is also available.

Applications with high static head are usually best addressed with centrifugal pumps in series.



**Multi-Stage Pump
Figure 41**

Multistage pumps can be thought of as “factory built multiple pumps in series.” As illustrated in Figure 41, each stage represents an impeller internally connected in series and driven by a common shaft. Each stage approximates having an additional pump in series. These stages cannot be operated separately as one could do with individual pumps in series. On the plus side, with a common shaft all impellers turn in unison at the same speed as the driver. Commonly the driver is a constant speed motor, but it could easily be variable speed. Controlling speed of electric motors for pumping applications is common place and well documented. Controlling variable multistage pumps in parallel is simple and has greater energy savings potential than trying to operate combinations of individual pumps in parallel and series.

An excellent choice for tall buildings would be a domestic water pressure booster system that could stage and control the speed of multistage pumps in parallel to save energy for all combinations of reduced flow and/or pressure requirements (see Figure 42). Pressure booster pump selections should be customized for the building type and mode of occupancy. For example one popular

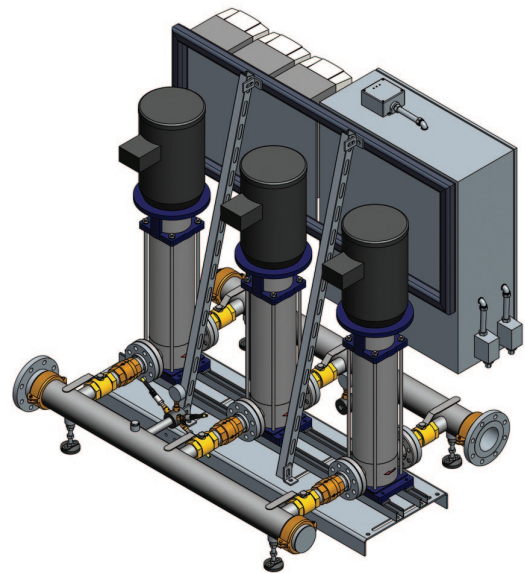

**Parallel, Multistage Domestic Water System Pump
Package
Figure 42**

selection for tall residential and office buildings is variable speed multistage pumps in parallel, each pump selected for $\frac{1}{2}$ the design flow and all pumps selected for the total design head. Another popular combination, particularly for lower first cost budgets using constant speed pumps is $\frac{2}{3}$, $\frac{2}{3}$, and $\frac{1}{3}$ flows (all at total design head). The $\frac{1}{3}$ capacity pump is referred to as the “jockey pump” and used in periods of low demand. The 2 other pumps are staged on demand. Note that for both options presented any two pump combination could deliver full design flow and head should any single pump fail.

This example was intended to give the designer a quick overview of how the theories of parallel and series pumping are used in tall office and residential buildings to achieve significant energy savings for domestic water pressure boosting applications. Pump controllers programmed to protect against no flow conditions, plus back-up mechanical means of controlling and relieving the thermal energy rise produced by pump dead heading should be incorporated into pressure booster design. More detailed pressure booster design information for constant or variable speed can be found in other Bell & Gossett Bulletins. Both bulletins are available from your local Bell & Gossett Representative (www.completewatersystems.com/resource-center/sales-distributor-contacts).

Pump Application Software

Bell & Gossett ESP-Plus® Online Program

The parallel and series applications described in this book require that the pump curves accurately portray actual pump operation. Without accurate curves it will be difficult to:

- Determine the stand-by flow from a single parallel pump,
- Properly size the piping,
- Choose a motor for non-overloading conditions for the desired operating points.

Even with accurate curves, the designer must spend valuable time in constructing the composite curves and system curves.

The online ESP-Plus® Program greatly simplifies parallel pump selection and application with the following capabilities:

- Select and compare multiple pump types
- Generate pump curves with system curves
- Graph variable speed pump curves
- Graph up to nine pumps in parallel
- Perform system modeling and variable speed cost analysis
- View pump specification
- View detailed engineering data
- Link to scaled CAD drawing
- Adjust selections for viscous fluids
- Request quote of selected pumps

For more information and free online registration go to: www.completewatersystems.com/brand/bell-gossett/selection-sizing-tools. A more extensive version that also selects expansion or compression tanks, heat exchangers, steam traps, steam valves and steam condensate transfer equipment is available on CD from your local Bell & Gossett Rep. (www.completewatersystems.com/resource-center/sales-distributor-contacts).

Bell & Gossett System Syzer® Program

A true Windows application with its own help screens, the System Syzer® program is not restricted to the physical size of the original plastic wheel version. It includes significantly more information and functions, such as:

- Expanded pipe size calculations through 48" diameter
- Displays of Reynolds numbers, flow rates, relative roughness and friction factors, along with friction loss and velocity values
- A viscosity correction feature that allows the user to adjust for different water temperatures up to 350°F and varying concentrations and temperatures of ethylene, propylene glycol and other fluids with known properties.
- A balance section with preset and gauge data for Circuit Setter, Large Circuit Setter and Triple Duty® Valves. The section also permits calculation adjustments based on fluid type and has a report generator to aid balancing contractors. The Bell & Gossett System Syzer® program is a free download at: www.completewatersystems.com/brand/bell-gossett/selection-sizing-tools/system-syzer.

Xylem |'zīləm|

- 1) The tissue in plants that brings water upward from the roots;
- 2) a leading global water technology company.

We're 12,500 people unified in a common purpose: creating innovative solutions to meet our world's water needs. Developing new technologies that will improve the way water is used, conserved, and re-used in the future is central to our work. We move, treat, analyze, and return water to the environment, and we help people use water efficiently, in their homes, buildings, factories and farms. In more than 150 countries, we have strong, long-standing relationships with customers who know us for our powerful combination of leading product brands and applications expertise, backed by a legacy of innovation.

For more information on how Xylem can help you, go to www.xyleminc.com



Xylem Inc.
8200 N. Austin Avenue
Morton Grove, Illinois 60053
Phone: (847) 966-3700
Fax: (847) 965-8379
www.xyleminc.com/brands/bellgossett

Bell & Gossett is a trademark of Xylem Inc. or one of its subsidiaries.
© 2012 Xylem Inc. TEH-1109A October 2012